

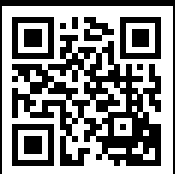

GRICOL

CATÁLOGO
MAESTRO
2016 - 2017







GRICOL



Somos una empresa dedicada a brindar soluciones integrales para el manejo del agua. Gracias a los materiales de ingeniería especialmente diseñados para brindar fortaleza y durabilidad a nuestros productos, nos especializamos en producir y comercializar grifería residencial e institucional, válvulas, porcelana sanitaria, lavaplatos, y complementos entre otros, de excelente calidad con un diseño innovador que le brinda a nuestros clientes más que una solución a su medida, una experiencia completa de elegancia y fiabilidad.

Somos una empresa comprometida no sólo con nuestros clientes, también con nuestros

trabajadores y con el medio ambiente. El cuidado y consumo del agua es responsabilidad de todos, por ello Gricol incluye en sus griferías reductores de caudal, que disminuyen hasta en un 70% su consumo, sin interferir con el desempeño normal de otros elementos como calentadores de agua.

Gracias a nuestra responsabilidad social, nos hemos comprometido a través de programas gratuitos, con la capacitación y formación de personas relacionadas o interesadas en la plomería y construcción. Para ello contamos con aulas propias y alianzas con instituciones, universidades, agremiaciones, comercializadoras y clientes.





Gricol fue Fundada en el año de 1962, por el Señor Víctor Romero, en la ciudad de Bogotá D.C. Colombia. Cinco décadas de trayectoria en el mercado nos han posicionado como referente de tradición, confianza, diseño y servicio. Creer en nuestro capital humano, desarrollar diseños de vanguardia y estar atentos a los cambios tecnológicos, es lo que nos ha permitido permanecer vigentes durante más de 50 años.

Buscando satisfacer de manera integral las necesidades de los usuarios, el mercado y el medio ambiente, Gricol ha sumado a sus productos las líneas de válvulas, lavaplatos, porcelana sanitaria, accesorios y productos institucionales.

Actualmente contamos con amplia cobertura en el mercado nacional e internacional, con operación propia en Perú desde 2012, y con representaciones de ventas en Venezuela, Ecuador, Panamá, Centro América y el Caribe a través de diferentes canales de distribución como ferreterías, grandes superficies, salas de acabados, constructoras e industrias.



MANUFACTURA

Latón, plásticos de alta ingeniería y toda una serie de materiales de alta calidad, que cumplen con las normas nacionales e internacionales NTC, ANSI y ASME, son la materia prima utilizada para la fabricación de nuestros productos. Contamos con un sistema de gestión de calidad certificado bajo la norma ISO 9001: 2008, por la entidad certificadora Bureau Veritas.

Somos merecedores del reconocimiento otorgado por el sistema de calidad ISO 9000 a nuestros procesos de control de calidad, garantizando una estabilidad en el tiempo, de la calidad de nuestros procesos y productos.

SOSTENIBILIDAD

Somos una empresa comprometida con el medio ambiente a través de actividades de clasificación y disposición de residuos reciclables, gestión integral de los residuos peligrosos y especiales, el control sobre los contaminantes ambientales; cumpliendo con la legislación aplicable y vigente, además de la implementación de sistemas de ahorro de agua y energía eléctrica.

ÍNDICE

RESIDENCIAL

GRIFERÍAS BAÑOS

DUCHAS - LAVAMANOS

LÍNEA EVOLUTION

Colección Kurven	010
Colección Vicctor	011
Colección Portobello	012
Colección Firenze Pala	013
Colección Firenze Cruz	014

LÍNEA CONTEMPRA

Colección Vivaldi	015
Colección Tiffany	016
Colección Sion	017
Colección Calima	018
Colección Pristina	020
Colección Tedesca	023
Colección Toscana	026
Colección Helvetia	028

LÍNEA GÉNESIS

Colección Piana	030
Colección Atlántico	032
Colección Helix Pala	034
Colección Helix Cruz	036

ACCESORIOS BAÑO

LÍNEA EVOLUTION

Colección Portobello	040
Colección Quadra	041

LÍNEA CONTEMPRA

	042
--	-----

LÍNEA GÉNESIS

	044
--	-----

REGADERAS Y DUCHAS TELÉFONO

Regaderas	048
Duchas Teléfono	051

GRIFERÍAS COCINAS

LAVAPLATOS

LÍNEA EVOLUTION

Colección Kurven	056
Colección Vicctor	056
Colección Firenze Pala	057
Colección Firenze Cruz	057

LÍNEA CONTEMPRA

Colección Vivaldi	058
Colección Tiffany	058
Colección Sion	059
Colección Calima	060
Colección Pristina	062
Colección Tedesca	064
Colección Toscana	066
Colección Helvetia	067

LÍNEA GÉNESIS

Colección Piana	068
Colección Atlántico	069
Colección Helix Pala	070
Colección Helix Cruz	071

COMPLEMENTOS PLOMERÍA

Desagües	074
Sifones baño	076
Conectores	076
Valvulas para tanque sanitario	077
Llaves de regulación	078
Sifones cocina	079
Canastillas	080

LAVANDERÍA Y EXTERIORES

Llaves lavadora	082
Llaves manguera	083
Llaves manguera extensión	084
Llaves terminal	085
Llaves terminal extensión	085

LAVAPLATOS

LÍNEA EVOLUTION	088
LÍNEA CONTEMPRA	091
LÍNEA GÉNESIS	092

PORCELANA SANITARIA

SANITARIOS - LAVAMANOS

LÍNEA EVOLUTION	
Colección Kurven	100
Colección Vicctor	100
Colección Portobello	100
Lavamanos	101
LÍNEA CONTEMPRA	
Colección Calima	103
Colección Pristina	103
Colección Tedesca	104
Lavamanos	104
LÍNEA GÉNESIS	
Colección Piana	106
Lavamanos	106

VÁLVULAS

ACUEDUCTOS	
Válvulas	110
Medidores para agua	112
Caja para medidor de agua	114
GAS NATURAL	
Válvulas	115

INSTITUCIONAL

DUCHAS	
Push	121
Balanceador de presión	121
Regaderas	122
Complementos	122

LAVAMANOS

Push	123
Sensor	124
Porcelana	125

SANITARIOS

Push	126
Sensor	126
Complementos	126
Porcelana	127

ORINALES

Push	130
Sensor	130
Complementos	131
Porcelana	131

ESPECIALIZADAS

Laboratorios	132
Cocinas Industriales	132
Brazos	133
Válvula Pie	134
Válvula Rodilla	134
Bebedero	135
Emergencia	135

BARRAS

Muro	136
Piso	137

ACCESORIOS

Cambia pañales	138
Canecas	138
Dispensador de papel	138
Dispensador de toallas	139
Dispensador de jabón	139
Espejo retractil	140
Perchero	140
Secador de pelo	140
Secador de manos	141
Tapa registro	141

REPUESTOS

REPUESTOS	144
-----------	-----





GRIFERÍAS BAÑOS

Duchas - Lavamanos

ATRIBUTOS DE PRODUCTO



Cartucho
cerámico



Monomando



Sistema de cierre
cerámico



Cierre
rápido - 1/4
de giro



Funciones
ducha



Cromo de
alta calidad



Capacitación -
Acompañamiento
a obra



Fácil
Instalación



Calidad
garantizada



KURVEN

línea EVOLUTION
Colección KURVEN



Ref. 01-3300-11

Ducha monomando
con ducha teléfono



Ref. 01-3301-11

Ducha monomando
sin salida tina



Ref. 01-3303-11

Monomando lavamanos bajo



Ref. 01-3306-11

Monomando lavamanos alto

DUCHA

LAVAMANOS



VICCTOR

línea EVOLUTION
Colección VICCTOR



Ref. 01-3401-11

Ducha monomando
sin salida tina



Ref. 01-3403-11

Monomando lavamanos bajo

DUCHA

LAVAMANOS



PORTOBELLO

línea EVOLUTION
Colección PORTOBELLO



Ref. 01-0228-11

Mezclador ducha 8"
3 llaves con salida tina



Ref. 01-0220-11

Mezclador ducha 8"
sin salida tina



Ref. 01-0208-11

Mezclador lavamanos 8" pared



Ref. 01-0203-11

Mezclador lavamanos 8"

DUCHA
LAVAMANOS



FIRENZE PALA

línea EVOLUTION
Colección FIRENZE PALA



NUEVO PRODUCTO



Ref. 01-3635-11
Mezclador ducha 8"
sin salida tina

DUCHA

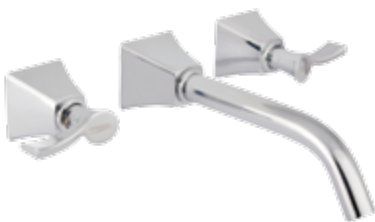

Ref. 01-3616-11
Mezclador lavamanos 8 " pared



Ref. 01-3603-11
Mezclador lavamanos 8"

LAVAMANOS



FIRENZE CRUZ

línea EVOLUTION
Colección FIRENZE CRUZ



NUEVO PRODUCTO



Ref. 01-3535-11

Mezclador ducha 8"
sin salida tina

DUCHA



Ref. 01-3516-11

Mezclador lavamanos 8 " pared



Ref. 01-3503-11

Mezclador lavamanos 8"

LAVAMANOS



VIVALDI

línea CONTEMPRA
Colección VIVALDI



Ref. 01-2101-11

Ducha monomando
sin salida tina



Ref. 01-2103-11SD

Monomando lavamanos bajo



Ref. 01-2106-11SD

Monomando lavamanos alto

DUCHA
LAVAMANOS



TIFFANY

línea CONTEMPRA
Colección TIFFANY



Ref. 01-2201-11

Ducha monomando
sin salida tina



Ref. 01-2203-11

Monomando lavamanos

DUCHA

LAVAMANOS



SION

NUEVO PRODUCTO

línea CONTEMPRA
Colección SION



Ref. 01-2601-11

Ducha monomando
sin salida tina

DUCHA



Ref. 01-2603-11

Monomando lavamanos bajo



Ref. 01-2606-11

Monomando lavamanos alto

LAVAMANOS



CALIMA

línea CONTEMPRA
Colección CALIMA



Ref . 01-0846-11

Mezclador ducha 8"
3 Llaves con salida tina



Ref . 01-0845-11

Mezclador ducha 8"
sin salida tina



Ref . 01-0823-11

Registro ducha

DUCHA



línea CONTEMPRA
Colección CALIMA



Ref. 01-0812-11

Mezclador lavamanos 8"



Ref. 01-0811-11

Mezclador lavamanos 4"



Ref. 01-0815-11

Llave individual lavamanos metal

LAVAMANOS



PRISTINA

línea CONTEMPRA
Colección PRISTINA



Ref. 01-2845-11

Mezclador ducha 8"
sin salida tina

Ref. 01-2844-11

Conjunto registro ducha



Ref. 01-2833-11

Registro ducha

DUCHA



línea CONTEMPRA
Colección PRISTINA



Ref . 01-2803-11

Mezclador lavamanos 8"



Ref . 01-2802-11

Mezclador lavamanos 4"



Ref . 01-2826-11

Mezclador lavamanos 8" pared



Ref . 01-2815-11

Llave individual lavamanos metal

LAVAMANOS



TEDESCA

GRIFERÍA · BAÑO



línea CONTEMPRA
Colección **TEDESCA**



Ref. 01-1822-11

Mezclador ducha 8"
con salida tina



Ref. 01-1835-11

Mezclador ducha 8"
sin salida tina



Ref. 01-1834-11

Conjunto registro ducha



Ref. 01-1833-11

Registro ducha

DUCHA



TEDESCA

línea CONTEMPRA
Colección **TEDESCA**



Ref. GS- 1816-11

Mezclador lavamanos 8" pared



Ref. 01-1803-11

Mezclador lavamanos 8"



Ref. 01-1823-11

Mezclador lavamanos 8"
brazo cobra

LAVAMANOS



línea CONTEMPRA
Colección TEDESCA

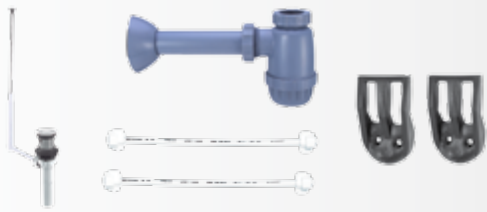

Ref. 01-1802-11

Mezclador lavamanos 4"

Ref. 01-1804-11

Conjunto mezclador lavamanos 4"



Ref. 01-1808-11

Mezclador lavamanos 4" bar



Ref. 01-1800-11

Llave individual lavamanos

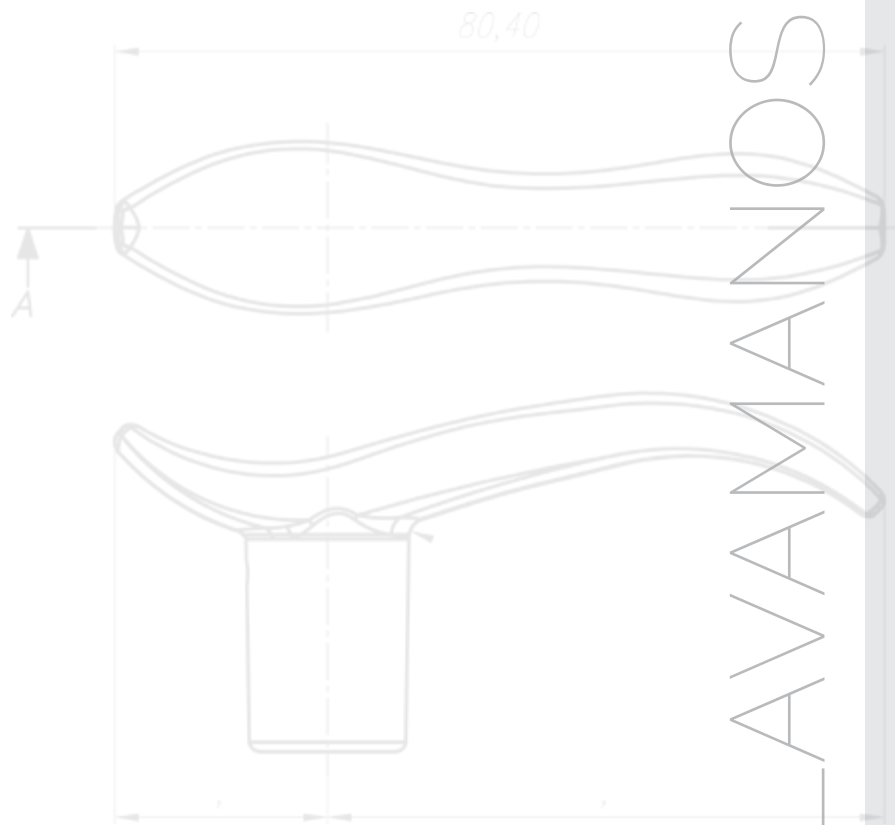



TOSCANA

línea CONTEMPRA
Colección TOSCANA



Ref. 01-1435-11

Mezclador ducha 8"
sin salida tina



Ref. 01-1434-11

Conjunto registro ducha



Ref. 01-1433-11

Registro ducha

DUCHA



Ref. 01-1403-11

Mezclador lavamanos 8" / 4"



Ref. 01-1402-11

Mezclador lavamanos 4"



Ref. 01-1462-11

Mezclador lavamanos 4"

Ref. 01-1471-11

Conjunto mezclador lavamanos 4"

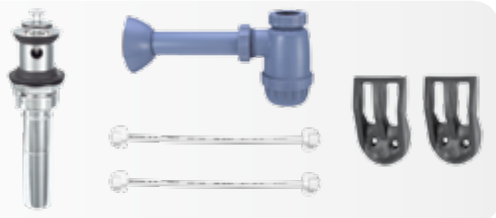

Ref. 01-1400-11

Llave individual lavamanos

LAVAMANOS



HELVETIA

línea CONTEMPRA
Colección HELVETIA



Ref . 01-0942-11

Mezclador ducha 8"
con salida tina



Ref . 01-0935-11

Mezclador ducha 8"
sin salida tina



Ref . 01-0934-11

Conjunto registro ducha



Ref . 01-0933-11

Registro ducha

DUCHA



línea CONTEMPRA
Colección HELVETIA

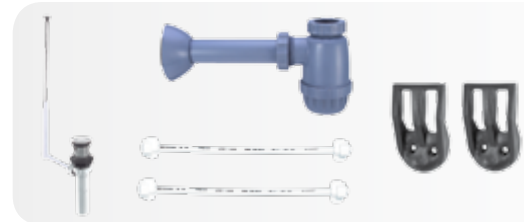
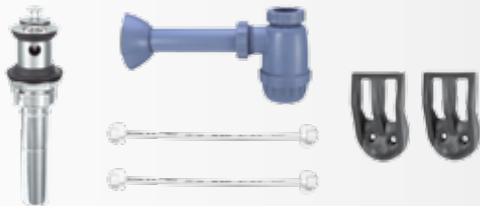

Ref. 01-0903-11

Mezclador lavamanos 8" / 4"

Ref. 01-0905-11

Conjunto mezclador lavamanos 8" / 4"

Ref.01-0902-11

Mezclador lavamanos 4"

Ref.01-0904-11

Conjunto mezclador lavamanos 4"



Ref.01-0900-11

Llave individual lavamanos

Ref.01-0901-11

Conjunto llave individual lavamanos

Ø 00,00 ± 0,0

Ø 0,0

LAVAMANOS



PIANA

línea GÉNESIS
Colección PIANA



Ref. 01-1535 -11

Mezclador ducha 8"
sin salida tina

Ref. 01-1534-11

Conjunto registro ducha



Ref. 01-1533-11

Registro ducha

DUCHA



línea GÉNESIS
Colección PIANA

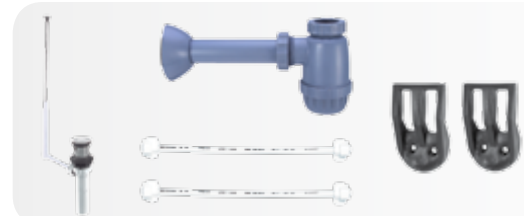
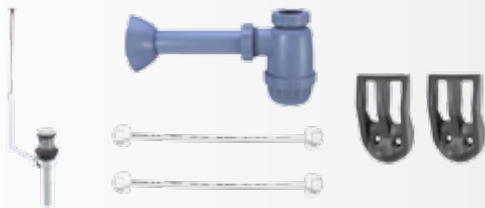

Ref. 01-1503-11

Mezclador lavamanos 8"

Ref. 01-1505-11

Conjunto mezclador lavamanos 8"

Ref. 01-1502-11

Mezclador lavamanos 4"

Ref. 01-1504-11

Conjunto mezclador lavamanos 4"



Ref. 01-1500-11

Llave individual lavamanos

Ref. 01-1501-11

Conjunto llave individual lavamanos

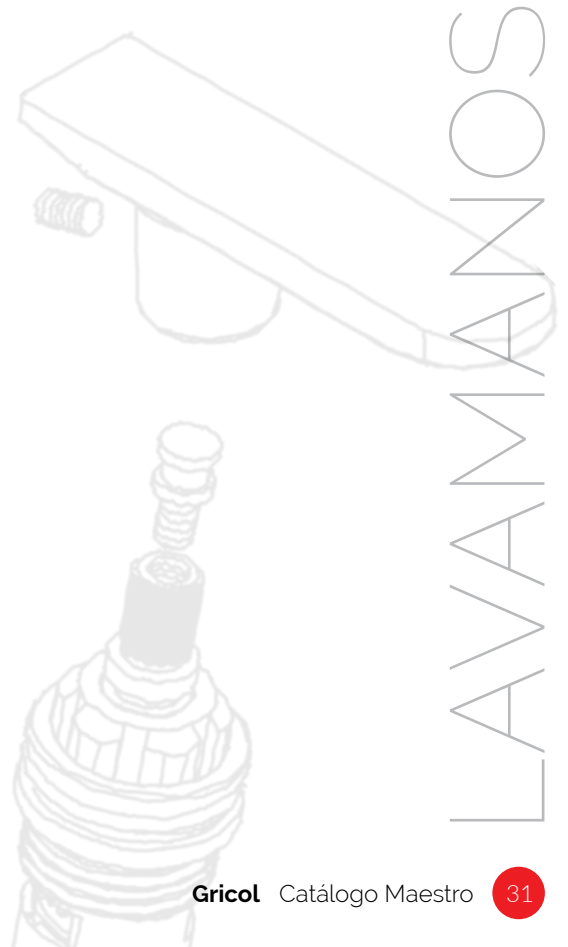



ATLÁNTICO

línea GÉNESIS
Colección ATLÁNTICO



Ref. 01-1335-11

Mezclador ducha 8"
sin salida tina

Ref. 01-1334-11

Conjunto registro ducha



Ref. 01-1333-11

Registro ducha

DUCHA



línea GÉNESIS
Colección ATLÁNTICO



Ref. 01-1303-11

Mezclador lavamanos 8"



Ref. 01-1302-11

Mezclador lavamanos 4"



Ref. 01-1300-11

Llave individual lavamanos





HELIX PALA

línea GÉNESIS
Colección HELIX PALA



Ref. 01-1735-11

Mezclador ducha 8"
sin salida tina



Ref. 01-1734-11

Conjunto registro ducha



Ref. 01-1733-11

Registro ducha

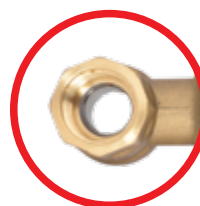
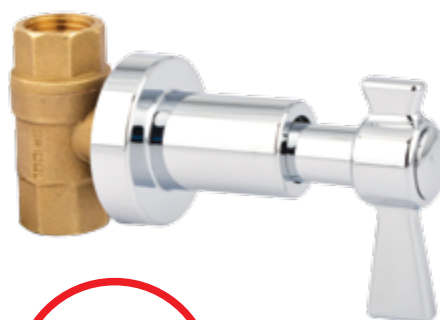

Paso total

Ref. 01-1770-11

Válvula esfera ducha

DUCHA



Ref. 01-1703-11

Mezclador lavamanos 8"



Ref. 01-1702-11

Mezclador lavamanos 4"



Ref. 01-1700-11

Llave individual lavamanos

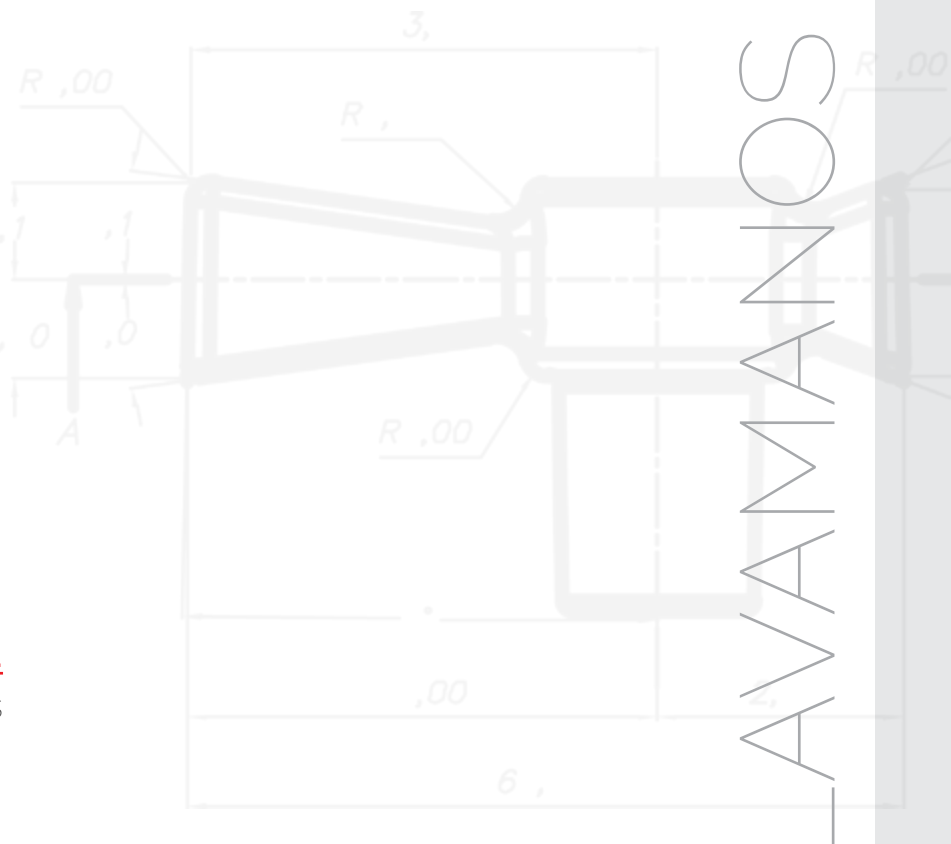



HELIX CRUZ

línea GÉNESIS
Colección HELIX CRUZ



Ref. 01-1635 -11

Mezclador ducha 8"
sin salida a tina

Ref. 01-1634-11

Conjunto registro ducha



Ref. 01-1633-11

Registro ducha

DUCHA



Ref.01-1603-11

Mezclador lavamanos 8"



Ref.01-1602-11

Mezclador lavamanos 4"

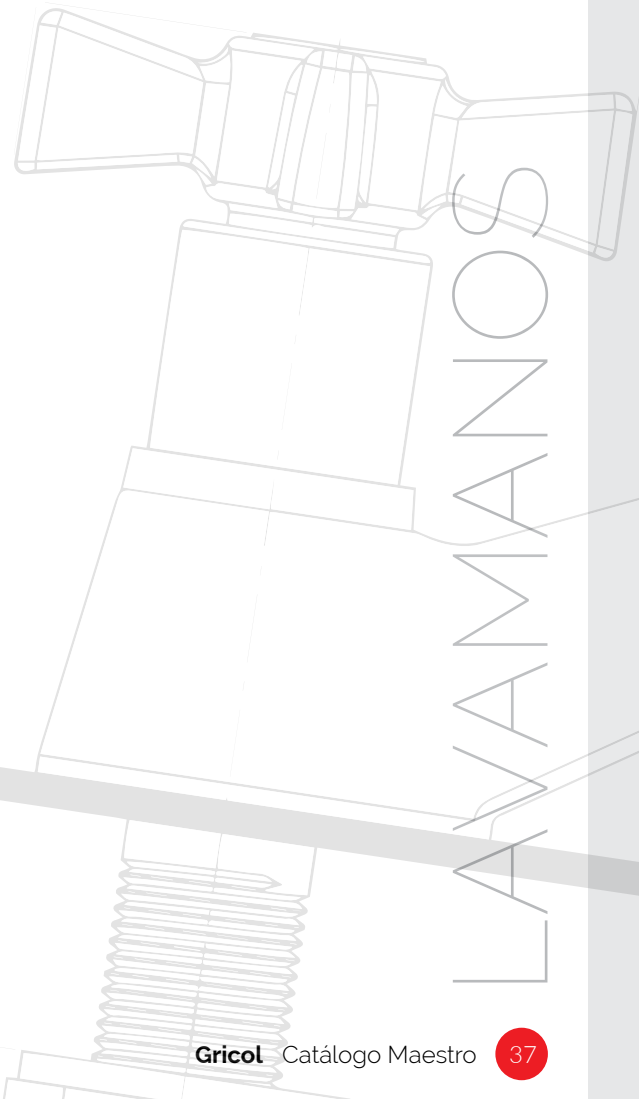

Ref.01-1600-11

Llave individual lavamanos

GRIFERÍAS BAÑOS

Accesorios







PORTOBELLO

línea EVOLUTION
ACCESORIOS



Ref.01-2553-11

Jabonera vidrio - metal

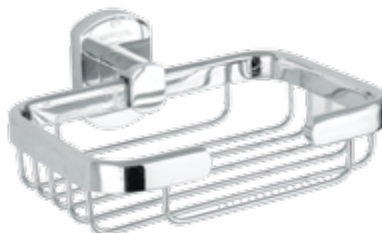

Ref.01-2554-11

Jabonera rejilla metálica



Ref.01-2555-11

Toallero barra metálico



Ref. 01-2556-11

Portacepillos
vidrio- metal



Ref. 01-2557-11

Portarollo metálico



Ref. 01-2558-11

Toallero aro metálico



Ref. 01-2559-11

Gancho metálico



QUADRA

línea EVOLUTION
ACCESORIOS



Ref.01-2453-11

Jabonera vidrio - metal



Ref.01-2457-11

Jabonera rejilla metálica



Ref.01-2454-11

Toallero barra metálico



Ref. 01-2456-11

Portacepillos
vidrio - metal



Ref. 01-2455-11

Portarollo metálico



Ref. 01-2458-11

Toallero aro metálico



Ref. 01-2459-11

Gancho metálico



Ref. BL-2502 -11

Gancho



Ref. BL-2503 -11

Portarollo



Ref. BL-2504 -11

Toallero aro



Ref. BL-2505 -11

Jabonera



Ref. BL-2506 -11

Portacepillos



Ref. BL-2507 -11

Toallero barra





CONJUNTOS

línea CONTEMPRA
ACCESORIOS



Ref. BL-2508-11

Conjunto 3 piezas



Ref. BL-2509-11

Conjunto 4 piezas

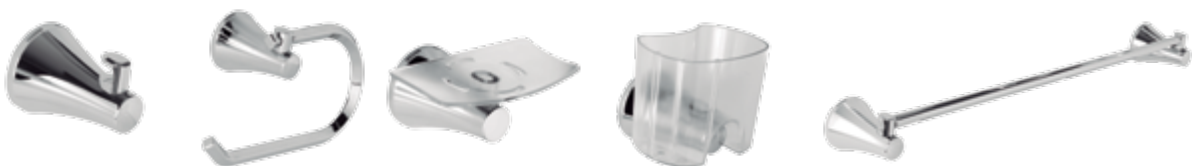

Ref. BL-2510-11

Conjunto 5 piezas



Ref. BL-2511-11

Conjunto 6 piezas



Ref. BL-2512 -11

Gancho



Ref. BL-2513 -11

Portarollo



Ref. BL-2514 -11

Toallero aro



Ref. BL-2515 -11

Jabonera



Ref. BL-2516 -11

Portacepillos



Ref. BL-2517 -11

Toallero barra





CONJUNTOS

línea GÉNESIS
ACCESORIOS



Ref. BL-2518-11

Conjunto 3 piezas



Ref. BL-2519-11

Conjunto 4 piezas

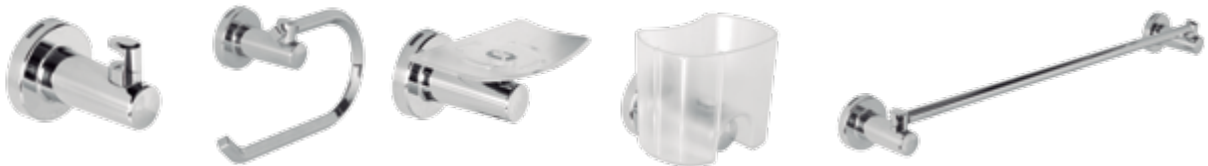

Ref. BL-2520-11

Conjunto 5 piezas



Ref. BL-2521-11

Conjunto 6 piezas





GRIFERÍA BAÑOS
Regaderas y duchas
teléfono



REGADERAS



26 X 19 cm

25 X 18 cm

Ref. BL-8030-11

Regadera Abruzzo

Ref. BL-8130-11

Regadera Abruzzo oval



20 cm



23 X 18 cm

Ref. BL-3330-11

Regadera Kurven

Ref. BL-3730-11

Regadera Torino



REGADERAS

**Ref. BL-8230-11**

Regadera Izmir 15 cm

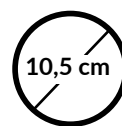
**Ref. BL-8430-11**

Regadera calima cromo

**Ref. BL-2430-11**

Regadera Helvetia

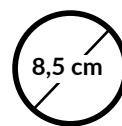
**Ref. BL-8330-11**

Regadera Izmir 8,5 cm



REGADERAS



Ref. BL-1630-11

Regadera Génesis II



Ref. BL-1430-11

Regadera Génesis I



Ref. RB-0418-11

Brazo regadera de lujo cromo



Ref. RB-0245-11

Tubo metal techo



DUCHAS TELÉFONO

150 cm
Metálica**Ref . BL-0694-11**

Ducha teléfono Abruzzo 8,5 cm

150 cm
Metálica**Ref . BL-0693-11**

Ducha teléfono Abruzzo 5,2 cm

150 cm
Plástica**Ref . BL-0698-11**

Ducha teléfono Izmir 15 cm

150 cm
Plástica**Ref . BL-0697-11**

Ducha teléfono Izmir 8,5 cm



DUCHAS TELÉFONO



150 cm
Plástica



Ref. TB-2000-11

Ducha teléfono + llave móvil pared



150 cm
Plástica



Ref. TB-1923-11

Ducha teléfono + desviador



150 cm
Plástica



Ref.01-1426-11

Mezclador lavacabezas 8"



Ref. RB-0593-11

Manguera metálica cromo 150 cm



DUCHAS TELÉFONO



Ref . RB-0596-11

Manguera plástica cromo 150 cm

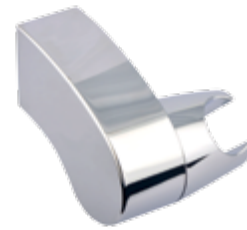

Ref . TB-0585-11

Soporte ducha teléfono móvil



Ref . TB-2570-11

Soporte doble función
conexión entrada 1/2" NPT



Ref . TB-0597-11

Adaptador ducha teléfono
conexión entrada 1/2" NPT



Ref . RB-1960-11

Desviador ducha teléfono
plástico conexión pared cromo



GRIFERÍAS COCINAS

Lavaplatos





KURVEN

línea EVOLUTION
Colección KURVEN



Ref. 01-3315-11

Monomando lavaplatos



Ref. 01-3515-11

Monomando lavaplatos
Kurven II

VICCTOR

línea EVOLUTION
Colección VICCTOR



Ref. 01-3415-11

Monomando lavaplatos



FIRENZE PALA

línea EVOLUTION
Colección FIRENZE PALA



NUEVO PRODUCTO



Ref. 01-3628-11

Mezclador lavaplatos 8"

FIRENZE CRUZ

línea EVOLUTION
Colección FIRENZE CRUZ



NUEVO PRODUCTO



Ref. 01-3528-11

Mezclador lavaplatos 8"



VIVALDI

línea CONTEMPRA
Colección **VIVALDI**



Ref. 01-2115-11

Monomando lavaplatos

TIFFANY

línea CONTEMPRA
Colección **TIFFANY**



Ref. 01-2209-11

Monomando lavaplatos



SION

línea CONTEMPRA

Colección SION



NUEVO PRODUCTO



Ref. 01-2615-11

Monomando lavaplatos

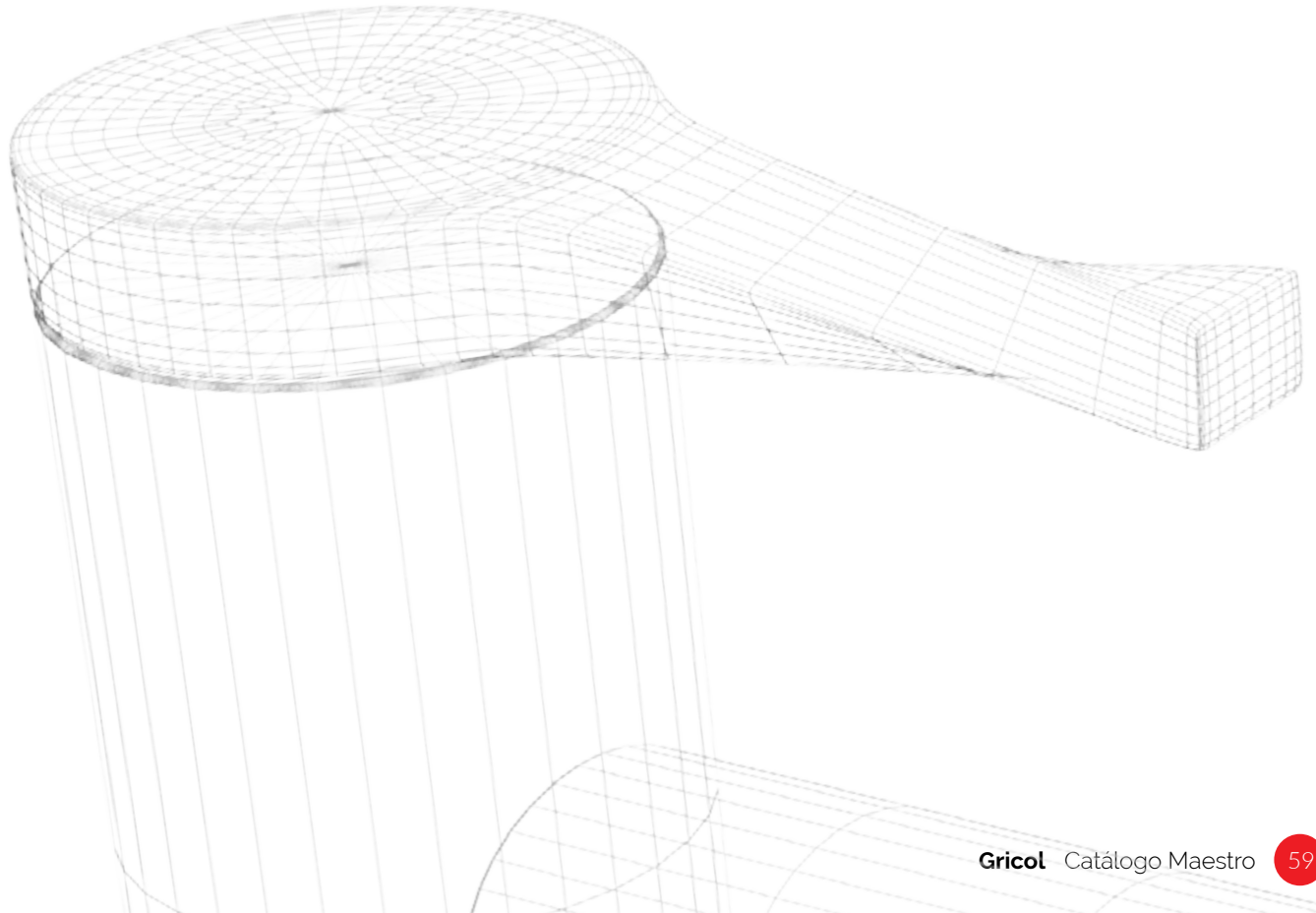



CALIMA

línea CONTEMPRA
Colección CALIMA



Ref. 01-0801-11

Mezclador lavaplatos 8" arco



Ref. 01-0841-11

Mezclador mesa 8" arco



Ref. 01-0832-11

Mezclador pared 8" arco



línea CONTEMPRA
Colección CALIMA



Ref. 01-0837-11

Llave móvil mesa arco
cuerpo metálico



Ref. 01-0834-11

Llave móvil pared C arco
cuerpo metálico



Ref. 01-0835-11

Llave móvil pared S
cuerpo metálico



PRISTINA

línea CONTEMPRA
Colección PRISTINA



Ref. 01-2828-11

Mezclador lavaplatos 8"



Ref. 01-2841-11

Mezclador mesa 8"



Ref. 01-2832-11

Mezclador pared 8"



línea CONTEMPRA
Colección PRISTINA



Ref. 01-2837-11

Llave móvil mesa
cuerpo metálico



Ref. 01-2864-11

Llave móvil pared C
cuerpo metálico



Ref. 01-2863-11

Llave móvil pared S
cuerpo metálico



TEDESCA

línea CONTEMPRA
Colección **TEDESCA**



Ref. 01-1828-11

Mezclador lavaplatos 8"

Ref. 01-1829-11

Conjunto mezclador lavaplatos 8"

Ref. 01-1850-11

Llave móvil mesa



Ref. 01-1853-11

Llave móvil pared C



línea CONTEMPRA
Colección TEDESCA



Ref. 01-1848-11

Mezclador lavaplatos 8" brazo cobra



Ref. 01-1869-11

Llave móvil mesa brazo cobra



Ref. 01-1868-11

Llave móvil pared S brazo cobra



Ref. 01-1852-11

Llave móvil pared C brazo cobra



TOSCANA

línea CONTEMPRA
Colección TOSCANA

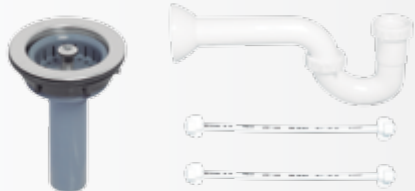
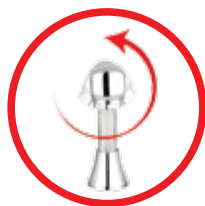

Ref. 01-1466-11

Mezclador lavaplatos 8"

Ref. 01-1474-11

Conjunto mezclador lavaplatos 8"

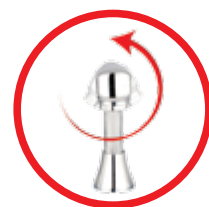

Ref. 01-1450-11

Llave móvil mesa



Ref. 01-1458-11

Llave móvil pared S



HELVETIA

línea CONTEMPRA
Colección HELVETIA



Ref. 01-0928-11

Mezclador lavaplatos 8" arco

Ref. 01-0929-11

Conjunto mezclador 8" arco



Ref. 01-0943-11

Llave móvil mesa arco

Ref. 01-0945-11

Conjunto llave móvil mesa arco



Ref. 01-0944-11

Llave móvil pared C



PIANA

línea GÉNESIS
Colección PIANA



Ref. 01-1528-11

Mezclador lavaplatos 8" cisne

Ref. 01-1529-11

Conjunto mezclador lavaplatos 8" cisne



Ref. 01-1550-11

Llave móvil mesa cisne

Ref. 01-1551-11

Conjunto llave móvil mesa cisne



Ref. 01-1553-11

Llave móvil pared C



Ref. 01-1558-11

Llave móvil pared S



ATLÁNTICO

línea GÉNESIS
Colección ATLÁNTICO



Ref. 01-1338-11

Mezclador lavaplatos 8" cisne

Ref. 01-1329-11

Conjunto mezclador lavaplatos 8" cisne



Ref. 01-1360-11

Llave móvil mesa cisne

Ref. 01-1357-11

Conjunto llave móvil mesa cisne



Ref. 01-1353-11

Llave móvil pared C



Ref. 01-1358-11

Llave móvil pared S



HELIX PALA

línea GÉNESIS
Colección HELIX PALA



Ref. 01-1728-11

Mezclador lavaplatos 8" cisne

Ref. 01-1729-11

Conjunto mezclador lavaplatos 8" cisne

Ref. 01-1750-11

Llave móvil mesa cisne

Ref. 01-1751-11

Conjunto llave móvil mesa cisne



Ref. 01-1753-11

Llave móvil pared C

Ref. 01-1758-11

Llave móvil pared S



HELIX CRUZ

línea GÉNESIS
Colección HELIX CRUZ



Ref. 01-1628-11

Mezclador lavaplatos 8" cisne

Ref. 01-1629-11

Conjunto mezclador lavaplatos 8" cisne



Ref. 01-1650-11

Llave móvil mesa cisne

Ref. 01-1651-11

Conjunto llave móvil mesa cisne



Ref. 01-1664-11

Llave móvil pared C



Ref. 01-1663-11

Llave móvil pared S



COMPLEMENTOS PLOMERÍA





COMPLEMENTOS PLOMERÍA



Ref. 01-2900-11

Desagüe push corto metal sin rebose cromo



Ref. 01-2904-11

Desagüe push corto metal con rebose cromo



Ref. 01-2906-11

Desagüe push largo metal sin rebose cromo



Ref. 01-2911-11

Desagüe push largo metal con rebose cromo



Ref. 01-1933-04

Desagüe automático con rebose gris cromo



Ref. 01-1938-11

Desagüe sencillo sin rebose cromo

**Ref. 01-1937-11**

Desagüe sencillo sin
rebose gris cromo

**Ref. 01-1936-11**

Desagüe sencillo con
rebose gris cromo

**Ref. RB-1970-07**

Soporte lavamanos (par)

**Ref. RB-0391-11**

Plataforma metálica 8" cromo

**Ref. RB-0392-11**

Plataforma metálica 4" cromo

**Ref. RB-0809-11**

Tapón metálico cromo



Ref. 01-1942-11

Sifón botella plástico 1 1/4" cromo

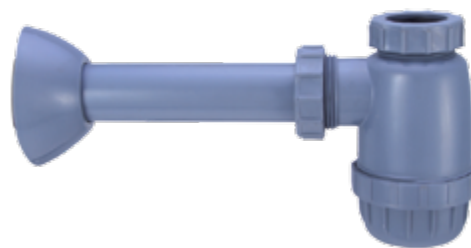

Ref. 01-1940-04

Sifón botella plástico 1 1/4" gris



Ref. RB-0388-11

Conector monoblock 45 cm
metal M 3/8" x H 1/2"



Ref. RB-0387-11

Conector lavamanos o lavaplatos
45 cm metal H-H 1/2" cromo



Ref. 01-1920-00

Conector lavamanos o lavaplatos
de 40 cm H-H 1/2"



Ref. 01-1921-00

Conector sanitario 40 cm
H 1/2" x H 7/8"

**Ref. 01-1911-15**

Válvula entrada sanitario

**Ref. 01-1910-11**

Válvula salida sanitario

**Ref. 01-1909-11**Conjunto grifería sanitario
manija cromo**Ref. 01-2912-15**

Válvula entrada hidrostática

**Ref. 01-2922-15**Válvula entrada hidrostática
graduable**Ref. 01-2915-11**Conjunto válvula entrada
hidrostática**Ref. 01-2923-15**Conjunto válvula entrada
hidrostática graduable

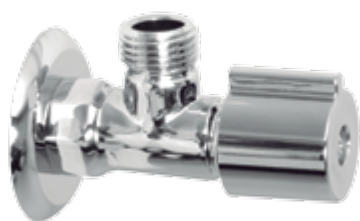

Ref. 01-9909-11

Llave de regulación metálica cromo



Ref. 01-1918-11

Llave regulación plástica cromo



Ref. 01-1999-11

Llave de Regulación 3/8" cromo



Ref. 01-1998-15

Llave regulación plástica blanco - cromo



Inserto Metálico

**Ref. 01-9996-11**

Sifón P metálico 1 1/2" ó 1 1/4"
cromo

**Ref. 01-9997-11**

Sifón P plástico 1 1/2" ó 1 1/4"
cromo

**Ref. 01-1941-15**

Sifón P plástico 1 1/2" ó 1 1/4"
blanco

**Ref. 01-2907-15**

Sifón expansible 1 1/2" ó 1 1/4"
blanco

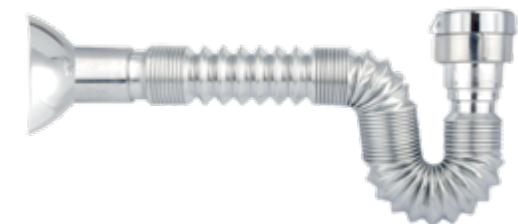
**Ref. 01-2907-11**

Sifón expansible 1 1/2" ó 1 1/4"
metálico

**Ref. 01-1945-15**

Conector T lavaplatos
doble poceta 1 1/2"

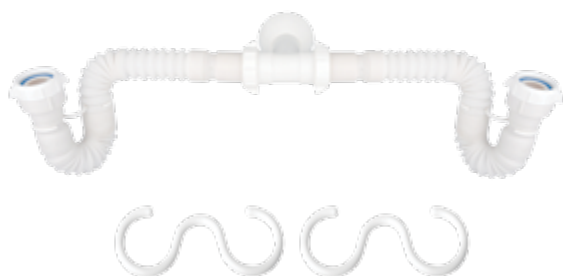

Ref. 01-2916-15

Sifón doble poceta expansible
blanco

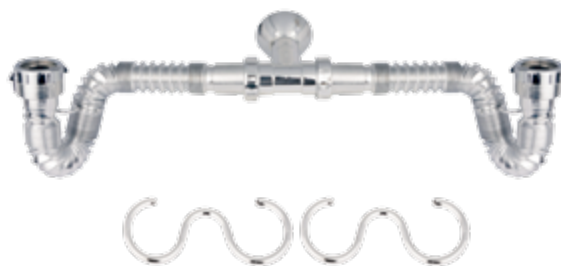

Ref. 01-2916-11

Sifón doble poceta expansible
metalizado



Ref. 01-1995-11

Canastilla 4" inox



Incluye filtro malla



Ref. 01-1953-11

Canastilla 4" tipo italiana
inox - inox



Incluye filtro malla

Ref. 01-1951-11

Canastilla 4" inox-plástico



Ref. 01-1954-11

Canastilla 2" filtro inox - inox



LAVANDERÍA Y EXTERIORES



LLAVES LAVADORA



Ref. 01-9915-11

Llave lavadora metal cromo



Ref. 01-1914-11

Llave lavadora plástica cromo



Ref. 01-9916-13

Llave lavadora metal satinada



Ref. 01-0511-15

Caja llaves lavadora 23x15x8 cm





LLAVES MANGUERA

**Ref. 01-9977-11**Llave manguera pesada metal
cromo**Ref. 01-9983-11**Llave manguera liviana metal
cromo**Ref. 01-9979-13**Llave manguera pesada metal
satin**Ref. 01-9983-13**Llave manguera liviana metal
satin**Ref. 01-9981-06**Llave manguera pesada metal
amarilla**Ref. 01-9983-06**Llave manguera liviana metal
amarilla



LLAVES MANGUERA

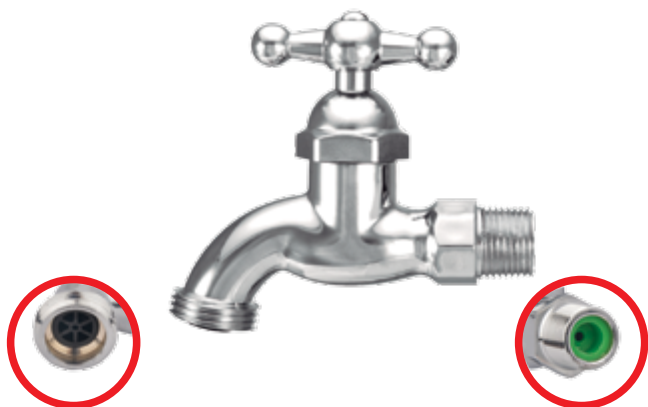

Ref. 01-1903-11

Llave manguera plástica cromo



Ref. 01-9954-11

Llave extensión manguera metal cromo



Ref. 01-1901-15

Llave manguera plástica blanca

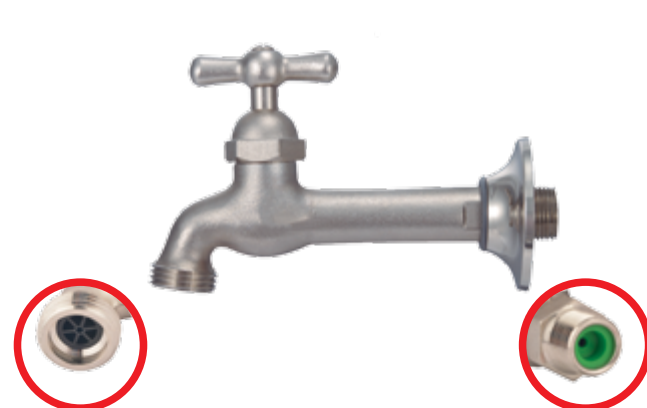

Ref. 01-9949-13

Llave extensión manguera metal satín



Ref. 01-2992-11

Llave extensión plástica manguera cromo



Ref. 01-9960-11

Llave extensión manguera metal cromo



LLAVES TERMINAL

**Ref. 01-9978-11**

Llave terminal pesada metal
cromo

**Ref . 01-9984-11**

Llave terminal liviana metal
cromo

**Ref. 01-9957-11**

Llave extensión terminal metal
cromo

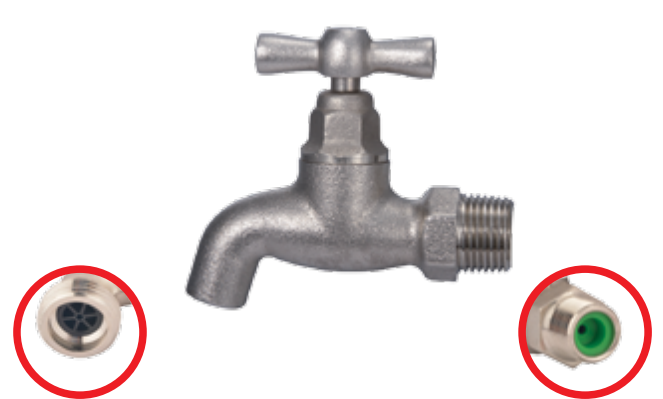
**Ref. 01-9984-13**

Llave terminal liviana metal
satín





LAVAPLATOS

ATRIBUTOS DE PRODUCTO



Sobreponer



Empotrar



Submontar



Mayor
profundidad



Doble
poceta
derecha

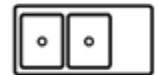

Doble
poceta
izquierda



Poceta
Derecha

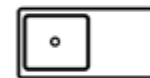

Poceta
izquierda

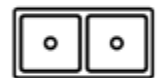

Doble
poceta



Alto brillo



Fácil
instalación



Calidad
garantizada



LAVAPLATOS

línea EVOLUTION
LAVAPLATOS

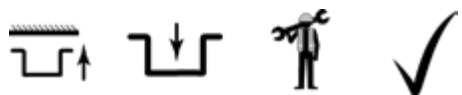

Ref. 01-3016-11

Kit lavaplatos acero
de 58.7 X 45.7 cm

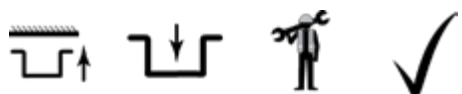

Ref. 01-3048-11

Kit lavaplatos acero
de 51 x 46 cm

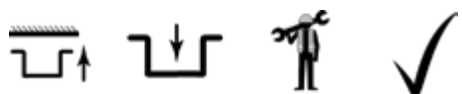

Ref. 01-3047-11

Kit lavaplatos acero
de 45 x 39 cm



línea EVOLUTION
LAVAPLATOS

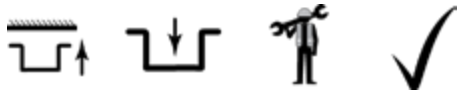

Ref. 01-3015-11

Kit lavaplatos acero
de 35 x 30 cm



Ref. 01-32106L-11

Kit lavaplatos acero
de 79.4 X 50.8 cm



Ref. 01-32106R-11

Kit lavaplatos acero
de 79.4 X 50.8 cm

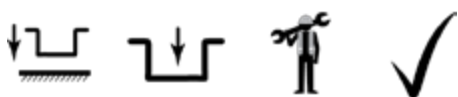

Ref. 01-21105-11

Kit lavaplatos acero de
67 X 48.5 cm





LAVAPLATOS

LAVAPLATOS

línea EVOLUTION
LAVAPLATOS

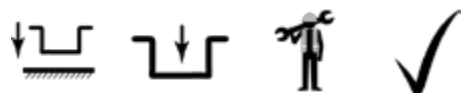

Ref. 01-31702-11

Kit lavaplatos acero
de 80 x 50 cm

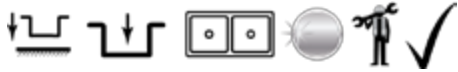

Ref. 01-3013-11

Kit lavaplatos acero
de 86 x 46 cm

Ref. 01-3026-11

Kit lavaplatos acero de
46.5 cm ø

Ref. M1-3020-11

Kit lavaplatos acero 120 x 50 cm
Mezclador 8"



U.E : 3 Unidades

Ref. M1-3021-11

Kit lavaplatos acero 120 x 50 cm
Mezclador 8"



U.E : 3 Unidades





LAVAPLATOS

línea GÉNESIS
LAVAPLATOS



Ref. M1-3000-11

Kit lavaplatos acero
de 100 x 50 cm
Mezclador 8"

U.E : 10 Unidades

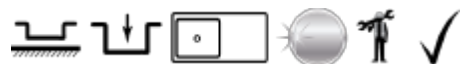

Ref. M1-3001-11

Kit lavaplatos acero
de 100 x 50 cm
Mezclador 8"

U.E : 10 Unidades



Ref. M1-3002-11

Kit lavaplatos acero
de 84 x 56 cm.
Mezclador 8"

U.E : 5 Unidades

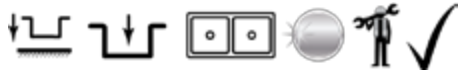
Ref. M1-3063-11

Kit lavaplatos acero
 de 84 x 56 cm
 Llave móvil



U.E : 5 Unidades

Ref. M1-3003-11

Kit lavaplatos acero
 de 94 x 48 cm
 Llave móvil



U.E : 10 Unidades

Ref. M1-3004-11

Kit lavaplatos acero
 de 94 x 48 cm
 Llave móvil



U.E : 10 Unidades





LAVAPLATOS

línea GÉNESIS
LAVAPLATOS



Ref. M1-3005-11

Kit lavaplatos acero
de 62 x 48 cm
Mezclador 8"



U.E : 10 Unidades



Ref. M1-3006-11

Kit lavaplatos acero
de 62 x 48 cm
Llave móvil



U.E : 10 Unidades



Ref. M1-3008-11

Kit lavaplatos acero
de 60 x 40 cm



U.E : 10 Unidades



Ref. M1-3043-11

Kit lavaplatos acero
 de 53 x 43 cm
 Llave móvil



U.E : 10 Unidades

Ref. M1-3060-11

Kit lavaplatos acero
 de 52 x 37 cm



U.E : 10 Unidades

Ref. M1-3078-11

Kit lavaplatos acero
 de 56 x 40 cm



U.E : 5 Unidades







PORCELANA

SANITARIA

Sanitarios - Lavamanos



ATRIBUTOS DE PRODUCTO



Redondo



Vessel



Incrustar



Alongado



Sobreponer



Asiento
caída lenta



Asiento
convencional



Fácil
Instalación



Calidad
garantizada

Clasificación de Sanitarios

AHORRADORES

13.2 lt

MAXIMA EFICIENCIA

3.8 lt



BAJO CONSUMO

6 lt

ALTA EFICIENCIA

4.8 lt

Clase de Sanitario



Una Pieza

Taza y tanque integrados



Dos Piezas

Taza y tanque separadas

Tipo de Taza

Redonda

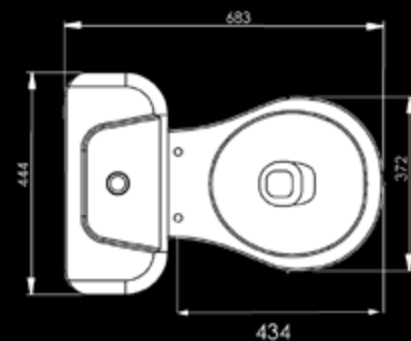

Alongada

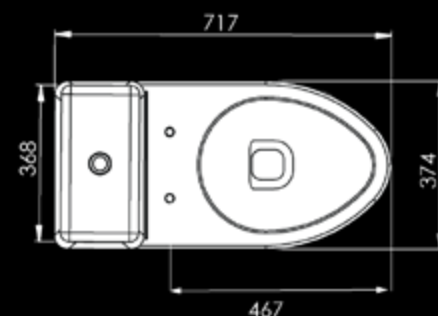

Características Sanitarios

1

EFICIENCIA



Una sola descarga, un solo consumo de agua.

Consumo de máxima eficiencia a través de una sola descarga (Elimina sistema doble descarga, líquidos y sólidos).

Consumo de 3.8 lt

2

SISTEMAS



No requiere sistema de presión asistida.

3

DISEÑO

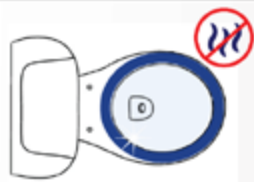

Anillo cerrado: Garantiza amplio espejo de agua y mayor limpieza de la taza, evita malos olores.

4

RUIDO



Bajo nivel de ruido.

5

HIGIENE



Sifón 100% esmaltado.

6

CAPACIDAD



Descarga eficiente, superior a los 650 g.

7

TECNOLOGÍA



Tecnología Jet.



Ref. 01-4021-15

Sanitario one piece
Kurven **4.8 Litros** blanco



Ref. 01-2036-15

Sanitario one piece
Vicctor **4.8 litros** blanco



Ref. 01-2094-15

Sanitario one piece
Portobello doble descarga
blanco



Ref. 01-4071-15

Vivaldi one piece doble descarga blanco



Ref. 01-2077-11

Kit lavamanos Burano



Ref. 01-4025-11

Kit lavamanos Nesso



Ref. 01-2053-15

Kit lavamanos Daly II blanco



Ref. 01-4062-15

Kit lavamanos Hestia blanco



Ref. 01-2078-15

Kit lavamanos Gea blanco



Ref. 01-2013-15

Kit lavamanos Stylo II blanco



Ref. 01-4006-15

Kit lavamanos de incrustar
Capri II ovalado blanco





Ref. 01-2068-15

Kit lavamanos Ada blanco



Ref. 01-2046-15

Kit lavamanos Terraza blanco



Ref. 01-2035-15

Kit sanitario alargado Calima **3.8 litros** blanco

Ref. 01-2035-22

Kit sanitario alargado Calima **3.8 litros** Marfil



Ref. 01-4034-15

Sanitario alargado Pristina **3.8 litros** blanco palanca

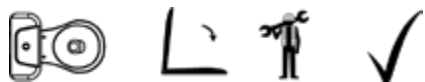

Ref. 01-2037-15

Sanitario redondo Pristina
3.8 litros blanco

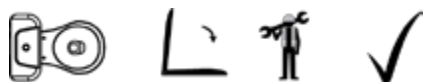

Ref. 01-4067-15

Sanitario redondo Tedesca
4,8 - 5,2 litros blanco



Ref. 01-4061-15

Kit lavamanos de incrustar
redondo blanco



Ref. 01-4019-15

Lavamanos de incrustar
Capri III ovalado blanco





Ref . 01-2029-15

Kit Lavamanos Oval II blanco



Ref . 01-4017-15

Kit Lavamanos de colgar con pedestal destroy II blanco



Ref . 01-4080-15

Lavamanos de colgar con pedestal Destroyer II blanco



Ref . 01-4079-15

Lavamanos Oval II blanco



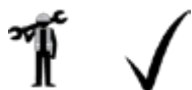

Ref. 01-2031-15

Kit lavamanos de colgar Destroyer II blanco

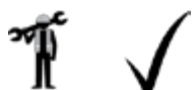

Ref. 01-4069-15

Lavamanos de colgar Destroyer II blanco

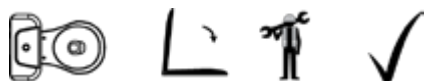

Ref. 01-2014-15

Sanitarios Piana 6 litros blanco



Ref. 01-2065-15

Combo sanitario + lavamanos con pedestal





Ref. 01-2015-15

Combo sanitario + lavamanos



Ref. 01-4078-15

Kit lavamanos de colgar con pedestal Hydrus II blanco

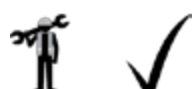

Ref. 01-4076-15

Kit lavamanos de colgar Vulcano blanco



Ref. 01-4081-15

Lavamanos de colgar Hydrus II blanco

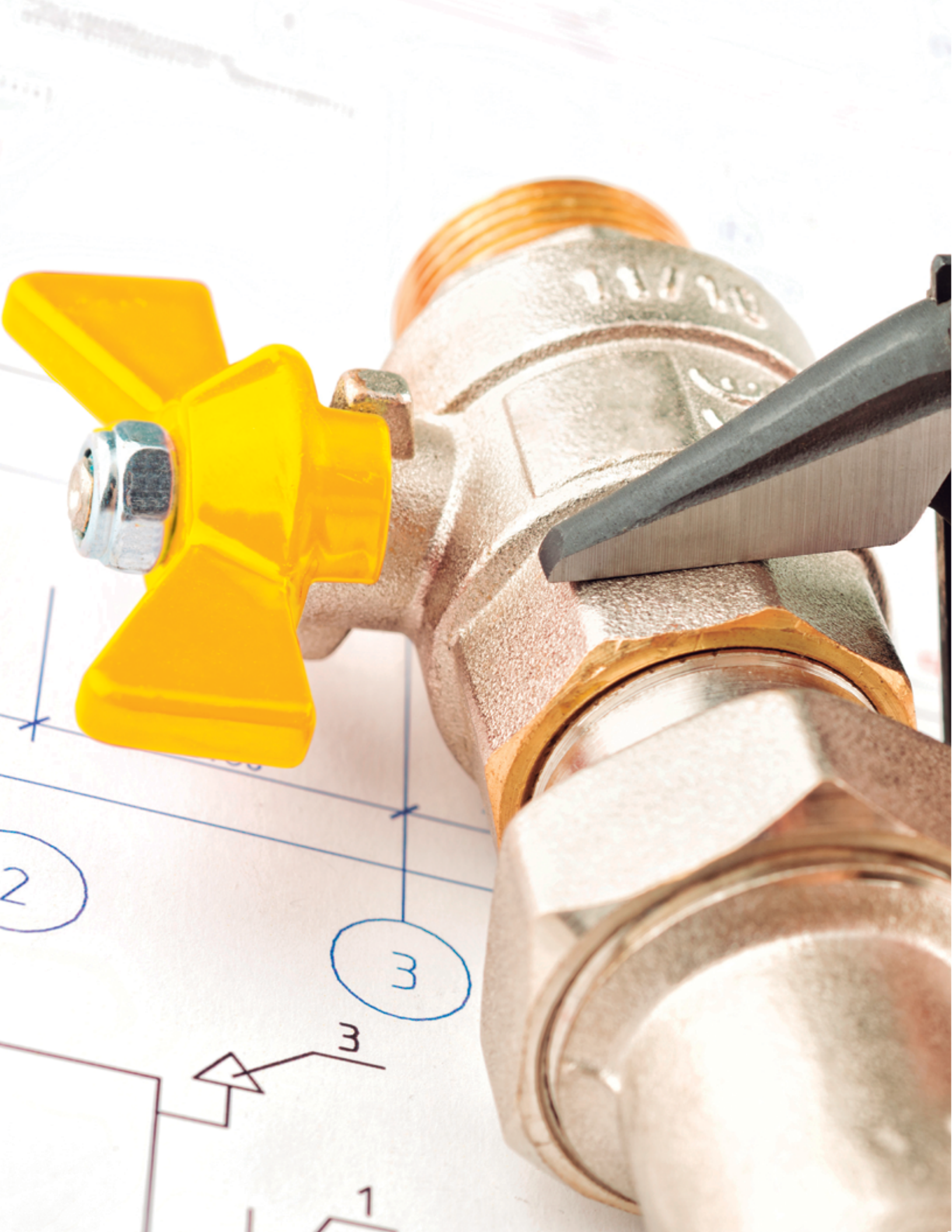



VÁLVULAS

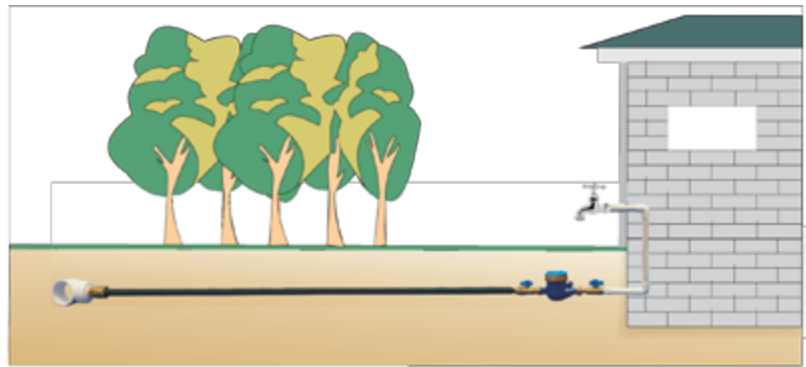

Acometida domiciliar en manguera



Acometida domiciliar en cobre

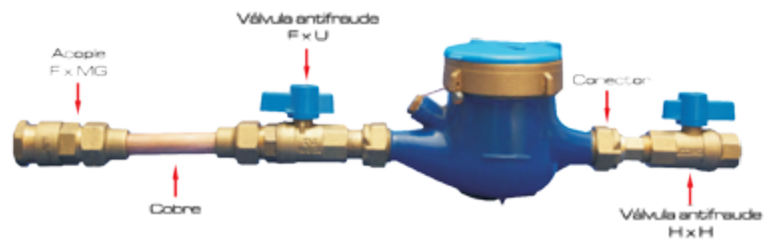

Acometida domiciliar en PVC

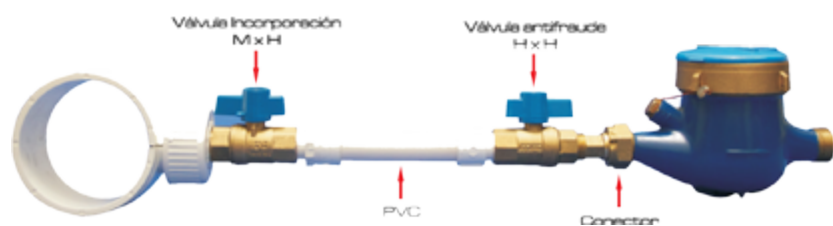



Ref. 10-0103-30

Válvula esfera agua 1/2 "

Ref. 10-0103-34

Válvula esfera agua 3/4 "

Ref. 10-0103-31

Válvula esfera agua 1"

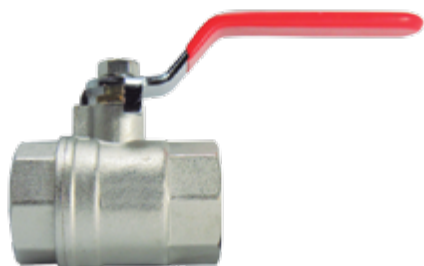

Ref. 10-0105-30

Válvula hembra 1/2" por hembra 1/2
(esfera)

Ref. 10-0105-34

Válvula hembra 3/4" por hembra 3/4
(esfera)

Ref. 10-0105-31

Válvula hembra 1" por hembra 1"
(esfera)



Ref. 10-0419-12

Válvula cortina 1/2"

Ref. 10-0418-12

Válvula cortina 3/4"

Ref. 10-0417-12

Válvula cortina 1"



Ref. 10-0302-02

Válvula de corte antifraude
hembra por hembra 1/2 "

Ref.10-0305-02

Válvula de corte antifraude
hembra por hembra 3/4 "

Ref. 10-0330-02

Válvula de corte antifraude
hembra por hembra 1"



Ref. 10-0328-02

Válvula de incorporación antifraude
hembra 1/2" por macho 1/2"

Ref. 10-0112-02

Válvula de incorporación antifraude
hembra 3/4" por macho 3/4"

Ref. 10-0107-02

Válvula de incorporación antifraude
hembra 1" por macho 1"



Ref. 10-0332-02

Válvula de corte antifraude
hembra 1/2"por manguera 16 mm

Ref. 10-0307-02

Válvula de corte antifraude
hembra 1/2"por manguera 20 mm

Ref. 10-0119-02

Válvula de corte antifraude
hembra 3/4"por manguera 25 mm

Ref. 10-0127-02

Válvula de corte antifraude
hembra 1"por manguera 32 mm



Ref. 10-0331-02

Válvula de incorporación antifraude macho 1/2" por manguera 16mm

Ref. 10-0308-02

Válvula de incorporación antifraude macho 1/2" por manguera 20mm

Ref. 10-0118-02

Válvula de incorporación antifraude macho 3/4" por manguera 25mm

Ref. 10-0106-02

Válvula de incorporación antifraude macho 1" por manguera 32mm



Ref. 10-0313-02

Válvula de corte antifraude hembra 1/2" por flare 1/2"

Ref. 10-0306-02

Válvula de corte antifraude hembra 3/4" por flare 3/4"



Ref. 10-0160-02

Válvula de corte mariposa hembra por hembra 1/2 "

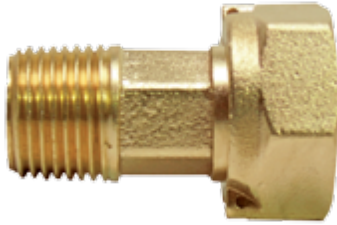

Ref. 10-0323-12

Conector de medidor agua 1/2"

Ref. 10-0109-12

Conector de medidor agua 3/4 "

Ref. 10-0121-12

Conector de medidor agua 1"

Ref. 10-0122-12

Conector de medidor agua 1 1/2"



Ref. 10-0126-12

Acople flare 1/2" por manguera 16mm

Ref. 10-0317-12

Acople flare 1/2" por manguera 20 mm



Ref. 10-0315-12

Acople flare 1/2 " por macho 1/2 "

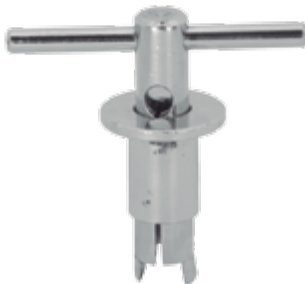

Ref. RB-0822-13

Llave para manija antifraude 1/2" y 3/4"

Ref. RB-0922-13

Llave para manija antifraude 1"



Ref. 10-0501-00

Medidor velocidad chorro único plástico
clase b o r50 alce calibrado

Ref. 10-0500-00

Medidor velocidad chorro único plástico
clase b o r50 alce sin calibrar

Ref. 10-0400-07

Medidor velocidad chorro único plástico
clase b o r63



Ref. 10-0401-12

Medidor velocidad chorro único bronce
clase b o r63



Ref. 10-0410-07

Caja medidor municipal con tapa en no
reciclable (Interbox)



Ref. 10-0411-07

Caja medidor municipal con tapa
no reciclable.(Ecobox)

Ref. 10-0160-06

Válvula de corte mariposa
hembra por hembra 1/2 "

Ref. 10-0132-06

Valvula incorporacion
macho 1/2" por universal 26 mm

Ref. 10-0111-06

Válvula de corte antifraude
hembra por hembra 3/8 "

Ref. 10-0302-06

Válvula de corte antifraude
hembra por hembra 1/2 "

Ref. 10-0305-06

Válvula de corte antifraude
hembra por hembra 3/4 "

Ref. 10-0330-06

Válvula de corte antifraude
hembra por hembra 1"



Ref. 10-0146-12

Elevador 1/2" cts (Hembra)

Ref. 10-0159-12

Elevador ips 1/2" rde 11 (Hembra)

Ref. 10-0160-12

Elevador ips 3/4" rde 11 (Hembra)

Ref. 10-0161-12

Elevador ips 1" rde 11 (Hembra)



Ref. 10-0115-12

Elevador 20 mm rde 11 (Macho)

Ref. 10-0327-12

Elevador 25mm rde 11 (Macho)

Ref. 10-0120-12

Elevador 32 mm rde 11 (Macho)



Ref. 10-0156-12

Elevador híbrido ips 1/2" rde 11 (Macho)

Ref. 10-0137-12

Elevador híbrido 20 mm rde 11 (Macho)

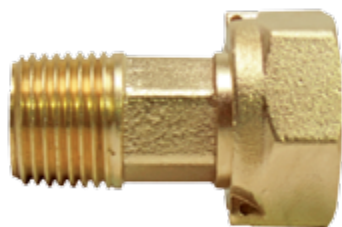
Ref. 10-0141-12

Conector al medidor m26 x g 2.5

Ref. 10-0322-12

Conector al medidor m26 x g 1.6

Ref. 10-0357-12

Conector al medidor g 4

Ref. 10-0416-12

Conjunto elevador válvula ips 1/2" rde 11

Ref. 10-0158-06

Conjunto elevador válvula 20 mm rde 11

Ref. 10-0200-12

Válvula glp gas propano



INSTITUCIONAL





ATRIBUTOS DE PRODUCTO

**ANTIVANDALISMO**

Debido a la alta frecuencia de vandalismo en los baños públicos, Gricol S.A cuenta con un amplio portafolio desarrollado para prevenir estas acciones garantizando seguridad y disminuyendo valores agregados causados por la reposición de piezas.

**GRIFERIAS DE SENSOR Y TEMPORIZADAS**

Gricol S.A posee variedad de productos creados para maximizar la eficiencia del agua a través de soluciones automáticas, contamos con productos desarrollados con la más alta tecnología orientados a la construcción sostenible, el manejo eficiente del agua y la consecución de puntos LEED.

**ACCESIBILIDAD**

Productos diseñados y pensados en el confort, seguridad y accesibilidad a los servicios sanitarios por parte de personas con dificultades en su movilidad.

**FACIL INSTALACIÓN**

Sistemas de instalación integrales, facilitan procesos de obra y se adaptan a cualquier tipo de construcción.

**CAPACITACIÓN - ACOMPAÑAMIENTO A OBRA**

Formamos y brindamos un completo plan de acompañamiento a plomeros, maestros de obra, técnicos hidráulicos, arquitectos e ingenieros en el proceso de especificación e instalación de nuestros productos.



Calidad garantizada.



DUCHAS

DUCHAS



Ref. ID-PU01-11

Válvula push ducha Gricol



Ref. ID-PA01-11

Mezclador ducha balanceo de presión



Ref. ID-CO06-11

Ducha teléfono institucional



DUCHAS



Ref. ID-RE01-11

Regadera antivandática



Ref. ID-CO04-15

Asiento abatible ducha





LAVAMANOS

LAVAMANOS



Ref. IL-PU02-11

Grifería lavamanos push mesa



Ref. IL-PU03-11

Grifería lavamanos push mesa liviana



Ref. IL-PU09-11

Válvula push lavamanos Gricol



Ref. IL-PU04-11

Conjunto válvula lavamanos push Gricol



LAVAMANOS

LAVAMANOS



Ref. IL-SE01-11

Grifería lavamanos sensor de mesa Easy



Ref. IL-SE02-11

Grifería lavamanos sensor de mesa Touch Free



Ref. IL-SE06-11

Grifería lavamanos sensor de mesa Brooklyn



Ref. IL-SE03-11

Grifería lavamanos sensor de pared Extreme Wm



LAVAMANOS

LAVAMANOS

**Ref. IL-PO04-15**

Lavamanos Oval

**Ref. IL-PO03-15**

Lavamanos discapacitados Oasis

**Ref. IL-PO01-15**

Lavamanos discapacitados Bari

**Ref. IL-PO02-15**

Lavamanos discapacitados Bari con soporte neumático



SANITARIOS



Ref. IS-PU05-11

Válvula sanitario push Gricol



Ref. IS-SE07-11

Fluxómetro sensor sanitario
Fénix



Ref. IS-SE04-11

Fluxómetro sensor sanitario
Venus



Ref. IS-CO01-11

Conexión posterior sanitario



SANITARIOS

SANITARIOS



Ref. IS-CO02-11

Conexión superior sanitario



Ref. IS-PO05-15

Taza de colgar conexión posterior
4.8 lpf Dominique



Ref. IS-PO06-15

Taza handicap conexión
superior 4.8 lpf Trani



Ref. IS-PO07-15

Taza handicap conexión
posterior 4.8 lpf Trani



SANITARIOS



Ref. IS-PO08-15

Taza conexión superior 4.8 lpf
Mondello



Ref. IS-PO09-15

Taza conexión posterior 4.8 lpf
Mondello



Ref. IS-PO10-15

Taza conexión posterior
semialongada 4.8 lpf Bellagio



Ref. IS-PO11-15

Taza handicap conexión posterior
con válvula pulsación suave



SANITARIO



Ref. IS-PO12-15

Sanitario handicap 4.8 lpf Imperia



Ref. IS-PO13-15

Sanitario infantil 4.8 lpf

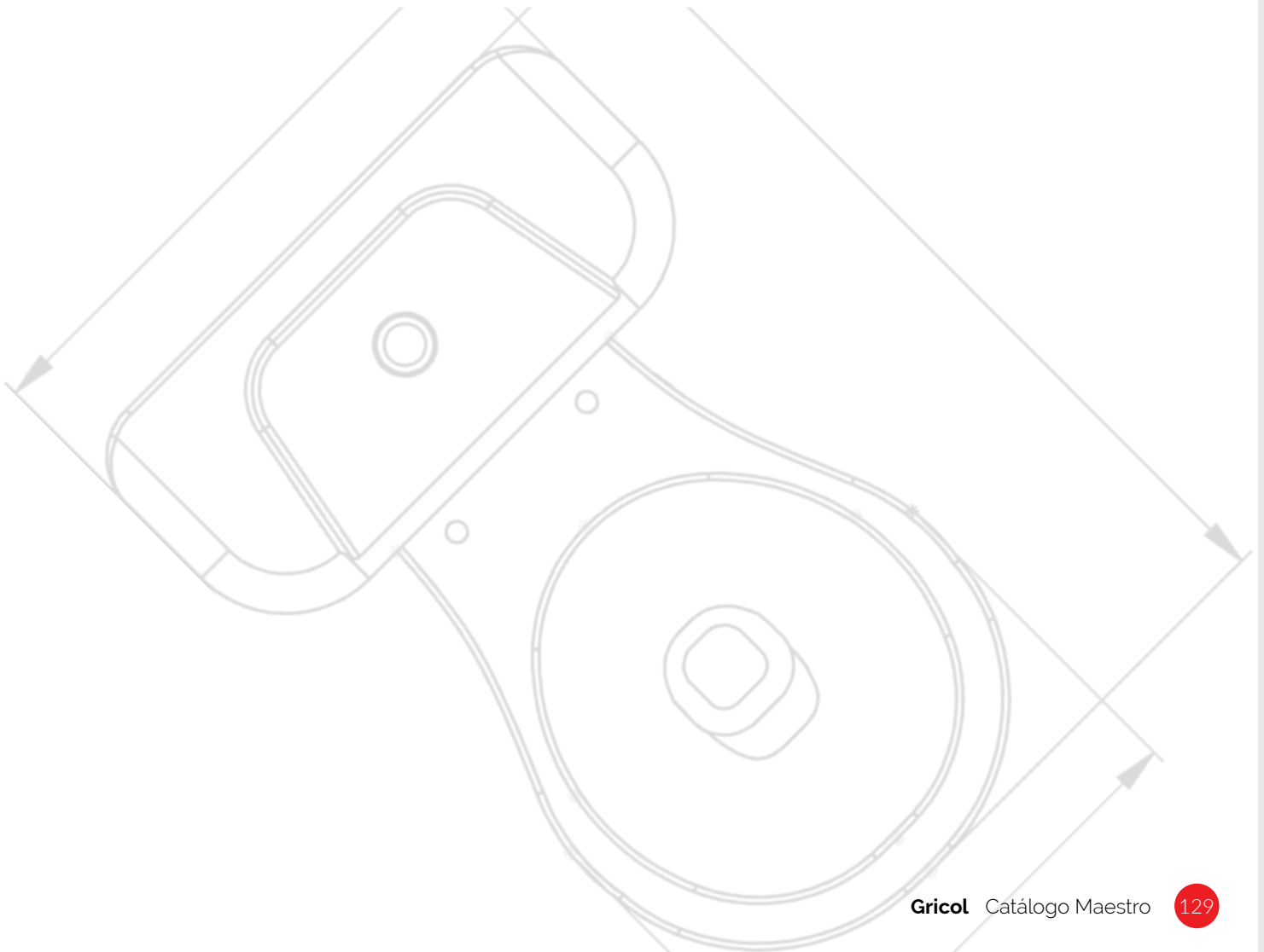



ORINALES

ORINALES



Ref. IO-PU06-11

Válvula orinal push Gricol



Ref. IO-PU07-11

Conjunto válvula orinal push Gricol



Ref. IO-PU08-11

Llave orinal push



Ref. IO-SE05-11

Fluxómetro sensor orinal Jupiter



ORINALES

ORINALES



Ref. IO-SE08-11

Fluxómetro sensor orinal SIRIUS



Ref. IO-CO03-11

Conexión superior orinal



Ref. IO-PO14-15

Orinal conexión superior 1.9 lpf
Tenerife



Ref. IO-PO17-15

Orinal ecológico Sunming (Seco)



ESPECIALIZADAS

ESPECIALIZADAS



Ref. II-LA01-11

Llave laboratorio sensor mesa
Dolphin F



Ref. II-LA02-11

Llave laboratorio sensor mesa
brazo alto Dolphin G



Ref. II-CI01-11

Mezclador brazo arco Institucional



Ref. II-CI02-11

Mezclador industrial con spray
cuello alto flexible pared



ESPECIALIZADAS

ESPECIALIZADAS



Ref. II-CI03-11

Mezclador industrial con spray
cuello alto flexible mesa



Ref. II-BR01-11

Brazo lavamanos metálico pared



Ref. II-BR02-11

Brazo arco institucional



Ref. II-BR03-11

Brazo arco institucional doble
poceta



ESPECIALIZADAS

ESPECIALIZADAS



Ref. II-VP01-13

Válvula pie un agua



Ref. II-VP02-13

Válvula mezcladora pie fijación a piso



Ref. II-VP03-13

Válvula mezcladora pie fijación a pared



Ref. II-VR01-11

Válvula de rodilla



ESPECIALIZADAS

ESPECIALIZADAS



Ref. II-BB01-13

Bebedero acero inoxidable



Ref. II-EM03-13

Lavaojos de colgar a pared acero
Inoxidable



Ref. II-EM01-06

Torre ducha mixta hierro
galvanizado 1"



Ref. II-EM02-13

Torre ducha mixta acero
inoxidable 1"



BARRAS



Ref. IB-MU01-13

Barra esquinera a muro ducha



Ref. IB-MU02-13

Barra sanitario tipo H



Ref. IB-MU03-13

Barra de apoyo abatible a muro



Ref. IB-MU04-13

Barra recta acero Inoxidable (800 mm)



BARRAS



Ref. IB-MU05-13

Barra recta acero Inoxidable (500 mm)



Ref. IB-MU06-13

Barra recta acero Inoxidable (300 mm)



Ref. IB-PI01-13

Barra de apoyo abatible a piso



Ref. IB-PI02-13

Barra en L a piso



ACCESORIOS



Ref. IA-CP01-04

Estación cambia pañales



Ref. IA-CA01-13

Caneca redonda acero inoxidable



Ref. IA-CA02-13

Caneca acero inoxidable con soporte para bolsa (400 x 300 x 120 mm)



Ref. IA-DP01-13

Dispensador papel higiénico acero inoxidable



ACCESORIOS



Ref. IA-DT01-13

Dispensador toallas
acero inoxidable



Ref. IA-DJ01-11

Dispensador de jabón mesa
sensor Smart 0.9 l



Ref. IA-DJ02-13

Dispensador jabón mesa 1 l



Ref. IA-DJ03-13

Dispensador jabón pared vertical 1 l



ACCESORIOS



Ref. IA-DJ04-13

Dispensador jabón pared horizontal 1 l



Ref. IA-ER01-11

Espejo retráctil con aumento



Ref. IA-PE01-13

Gancho perchero doble



Ref. IA-SP01-15

Secador de pelo manual



ACCESORIOS



Ref. IA-SM01-11

Secador de manos ultra eficiente en acero inoxidable



Ref. IA-SM02-15

Secador de manos en ABS blanco



Ref. IA-TR01-13

Tapa registro acero inoxidable
(200 x 200 mm)



GRICOL

REPUESTOS



REPUESTOS



Ref. RB-1149-00

Manija grande botón azul kristhal



Ref. RB-1151-00

Manija pequeña kristhal grafilado



Ref. RB-1623-11

Manija helix cruz 22 mm ducha y lavamanos



Ref. RB-1723-11

Manija helix pala 22 mm ducha y lavamanos



Ref. RB-1523-11

Manija plana 22 mm ducha y lavamanos



Ref. RB-1823-11

Manija tedesca 22 mm ducha y lavamanos



Ref. RB-1424-11

Manija toscana 22 mm ducha y lavamanos



Ref. RB-1423-11

Manija helvetia 22 mm ducha y lavamanos



Ref. RB-2823-11 Der
Ref. RB-2822-11 Izq

Manija pristina 22 mm ducha y lavamanos



Ref. RB-0822-11

Manija calima 22 mm ducha y lavamanos



Ref. RB-0223-11

Manija portobello 22 mm
ducha y lavamanos



Ref. RB-2712-11

Manija torino 22 mm ducha y
lavamanos



REPUESTOS



Ref. RB-0192-11

Escudo ducha kristhal



Ref. RB-1400-11

Escudo ducha génesis



Ref. RB-1800-11

Escudo ducha contemptra



Ref. RB-1401-11

Escudo lateral lavamanos génesis



Ref. RB-1801-11

Escudo lateral lavamanos
contemptra



Ref. RB-0145-11

Escudo lateral lavamanos kristhal



Ref. RB-0030-11

Escudo lateral lavamanos
evolution



Ref. RB-0053-11

Escudo llave móvil pared



Ref. RB-9988-07

Tapón cuerpo ducha (Par)



Ref. RB-0275-15

Cartucho monomando ducha 40 mm



Ref. RB-0276-15

Cartucho monomando lavamanos 35 mm



Ref. RB-0684-12

Torre central ducha lujo



REPUESTOS



Ref. RB-0198-12

Torre ducha antigua rosca fina 22.5 mm



Ref. RB-0271-12

Torre ducha antigua rosca ordinaria



Ref. RB-0685-12

Torre central ducha platino



Ref. RB-0290-12

Torre ducha cierre cerámico derecho



Ref. RB-0292-12

Torre ducha cierre cerámico izquierdo



Ref. RB-0567-12

Prolongador montura ducha



Ref. RB-0429-12

Porta escudo ducha metálico



Ref. RB-0428-12

Porta escudo ducha plástico



Ref. RB-0270-13

Torre múltiple metálica hexágono móvil grafilada



Ref. RB-0291-12

Torre múltiple metálica cierre cerámico derecho



Ref. RB-0293-12

Torre múltiple metálica cierre cerámico izquierdo



Ref. RB-0201-15

Torre múltiple plástico cierre cerámico derecha



REPUESTOS



Ref. RB-0201-02

Torre múltiple plástico cierre cerámico izquierdo



Ref. RB-0200-15

Torre múltiple plástica hexágono móvil grafilada



Ref. RB-0230-11

Brazo metal lavamanos pared



Ref. RB-0540-11

Brazo lavamanos cobra



Ref. RB-1898-11

Brazo lavamanos Tedesca



Ref. RB-0610-11

Brazo lavamanos Helvetia



Ref. RB-0295-11

Brazo 19 mm lavaplatos tipo cisne



Ref. RB-0296-11

Brazo lavaplatos tipo C de 19mm cromo



Ref. RB-0397-11

Brazo tipo S 19 mm llave móvil pared cromo



Ref. RB-0543-11

Brazo lavaplatos cobra



Ref. RB-0602-11

Brazo plástico arco lavaplatos



Ref. RB-1897-11

Brazo lavaplatos Tedesca



REPUESTOS



Ref. RB-0297-11

Brazo cisne plástico 19mm



Ref. BL-2360-11

Aireador dirigible metal



Ref. RB-0280-00

Aireador completo 18 mm con rosca interna



Ref. RB-0279-00

Aireador completo 18 mm con rosca externa



Ref. RB-0117-00

Kit brazo lavaplatos 19 mm
2 empaques y una arandela



Ref. RB-0285-11

Salida a tina plástica con botón
desactivador cromo



Ref. RB-0286-11

Salida a tina plástica cromo



Ref. RB-1915-15

Tornillo de fijación tanque sanitario (par)



Ref. RB-9708-11

Manija válvula salida



Ref. RB-9718-15

Sello lengüeta válvula salida
sanitario



Ref. RB-9728-11

Filtro 2" acero inox canastilla italiana



Ref. RB-9702-15

Filtro plástico 4" blanco
(polipropileno)



REPUESTOS



Ref. RB-9701-11

Filtro completo 4" acero inox



Ref. RB-9727-11

Filtro 4" acero inox canastilla italiana



Ref. RB-9705-13

Manija llave terminal satinada



Ref. RB-9706-11

Manija llave terminal cromada



Ref. RB-0091-11

Manija llave jardín cromo



Ref. RB-9704-12

Manija llave terminal amarilla



Ref. RB-0091-12

Manija llave jardín satín



Ref. RB-0085-07

Empaque árbol llave terminal (par)



Ref. RB-0582-11

Prolongador desagüe



Ref. RB-9712-15

Adaptador sifón



Ref. RB-0097-07

Adaptador caucho sifón



Ref. RB-0156-07

Tapón plástico 2"



GARANTIA

Los productos fabricados y comercializados por Gricol S.A. están cubiertos por garantía de:

Griferías, accesorios y complementos, veinte (20) años.

Porcelana Sanitaria, ilimitada y limitada en accesorios

Lavaplatos cinco (5) años.

Institucional, de acuerdo a la garantía otorgada por la marca comercializada para cada producto.

Esta garantía cubre defectos de fabricación y/o mala calidad de los materiales.

En caso de presentarse una garantía por lo antes mencionado y previa verificación del personal técnico de Gricol S.A., la empresa repara el producto o pieza averiada y se hará cargo de los gastos generados por la falla del producto, en ningún caso esta garantía aplica para cambio por un producto nuevo.

La garantía no cubre mal funcionamiento o partes deterioradas por consecuencia de una incorrecta

instalación, el uso inadecuado, el desgaste natural, mal mantenimiento, residuos en el sistema hidráulico, repuestos de otras marcas, adaptaciones, productos abrasivos, limpiadores inadecuados y solventes. Es obligatorio seguir las instrucciones de instalación y uso incluidas en el producto.

* Los productos fabricados por Gricol S.A son de uso doméstico, esta garantía no tendrá validez si el producto recibe un uso diferente al especificado. (No aplica para línea institucional)

Si se presenta una reclamación y/o servicio por inconvenientes que no cubre la garantía, Gricol S.A. se reserva el derecho de cobrar por el servicio, repuestos utilizados, asesoría, traslado, y/o gastos generados por el servicio.

Para quejas, preguntas, reclamos, dudas, inquietudes o sugerencias por favor comuníquese con nosotros al:

Tel: (1) 360 38 99 - (1) 360 04 66,

e-mail: info@gricol.com

serviciotecnico@gricol.com

www.gricol.com

ORDENES DE PEDIDO

* Todas las órdenes sobre pedido tienen un tiempo estimado de surtimiento de 6 a 8 semanas.

* Los precios de todos los productos ordenados sobre pedido son estimados, si al momento de surtirse el producto su precio es mayor al estimado, el cliente deberá pagar la diferencia para liberar el pedido. Si el precio es menor al estimado, la diferencia quedará como saldo a favor del cliente.

* La cotización de orden sobre pedido tiene vigencia de 30 días sin excepción



GENERALIDADES

1. La entrega de todo pedido despachado por Gricol S.A, implica por parte del comprador la aceptación de las presentes condiciones generales.
2. Todas las cláusulas o cartas de garantía expedidas por Gricol S.A., de los productos adquiridos por el comprador, de acuerdo a las presentes condiciones no pueden ser objeto de oposición a menos que ellas hayan sido aceptadas por escrito de nuestra parte.
3. Los pesos, especificaciones, dimensiones e información indicadas en catálogos y productos, no son más que indicativos y nunca constituyen una obligación. Nuestros modelos pueden ser modificados o discontinuados en cualquier momento y sin previo aviso, sin incurrir en ninguna responsabilidad ni indemnización.
4. Los Precios, descripciones y detalles de los productos se encuentran sujetos a Cambio y sin Previo Aviso
5. Precios y existencias sujetas a disponibilidad en el almacén mayorista o del fabricante.
6. Todas las órdenes están sujetas a los Términos y Condiciones de uso de Gricol S.A
7. Todos los productos tienen garantía original con el fabricante. Por lo que el cliente debe contactar al fabricante para cualquier soporte técnico o garantía.
8. Cualquier anulación de órdenes o cambios en las mismas deberán de hacerse contactando a su gestor de negocios o a la línea de servicio al cliente al 5 - 7 - 1 - 3603899.
9. Todas las órdenes están sujetas a un tiempo de proceso de hasta 3 días hábiles de Lunes a Sábado.
10. Si Usted solicita el envío a direcciones alternas su envío puede durar un día extra con el propósito de verificar la dirección.
11. Gricol S.A no procesa órdenes ni hace envíos domingos y festivos.
12. En inventario de baja rotación existen límites en las cantidades.
13. La existencia de los productos confirmada por el gestor de negocios de Gricol S.A, es al momento de hacer su pedido, en dado caso que el pago del mismo no se acredite el mismo día, podrá ser cancelado el apartado quedando los productos sujetos a asignarse a otras órdenes posteriores.





CARRERA 34 No 8a - 15
BOGOTÁ - COLOMBIA
info@gricol.com
serviciotecnico@gricol.com
Tels. (57-1) 360 38 99 / 360 04 66
Fax. (57-1) 237 48 60
WWW.GRICOL.COM